



50Ω TERMINATED 18 GHz SMA LATCHING S.P.5 T. SWITCH

OPTIONS: INDICATOR /SELF CUT-OFF /AUTO RESET /SUPP.DIODES

R F CHARACTERISTICS

NUMBER OF WAYS : 5
 FREQUENCY RANGE : 0 - 18 GHz
 IMPEDANCE : 50 Ohms

FREQUENCY (GHz)	0 - 3	3 - 8	8 -12.4	12.4- 18
V.S.W.R <=	1.20	1.30	1.40	1.50
INSERT. LOSS <=	0.20 dB	0.30 dB	0.40 dB	0.50 dB
ISOLATION >=	80 dB	70 dB	60 dB	60 dB
AVER. POWER (*)	120 W	80 W	60 W	50 W

TERMINATION IMPEDANCE : 50 Ohms
 TERMINATION AVG. POWER AT 25° C : 1 W per termination
 3 W total power

ELECTRICAL CHARACTERISTICS

ACTUATOR : LATCHING
 NOMINAL CURRENT AT 25° C (±10%) : 375 mA
 ACTUATOR VOLTAGE (Vcc) : 28V (24 to 30V) / NEGATIVE COMMON
 TERMINALS : 25 pins D-SUB male connector
 INDICATOR RATING : 1 W / 30 V / 100 mA
 SELF CUT-OFF TIME : 40 ms < CT < 120 ms

MECHANICAL CHARACTERISTICS

CONNECTORS : SMA female per MIL-C 39012
 LIFE : 2.000.000 cycles per position
 SWITCHING TIME (nominal voltage;25° C) : < 40 ms
 CONSTRUCTION : splashproof
 WEIGHT : < 250 g

ENVIRONMENTAL CHARACTERISTICS

OPERATING TEMPERATURE RANGE (°C) : -40 , +85
 STORAGE TEMPERATURE RANGE (°C) : -55 , +85

(* : average power at 25° C per RF path)

This information is given as an indication. In the continual goal to improve our products, we reserve the right to make any modifications judged necessary

4112-9212

DRAWING

General tolerance: ± 0,5 mm

R574 493505

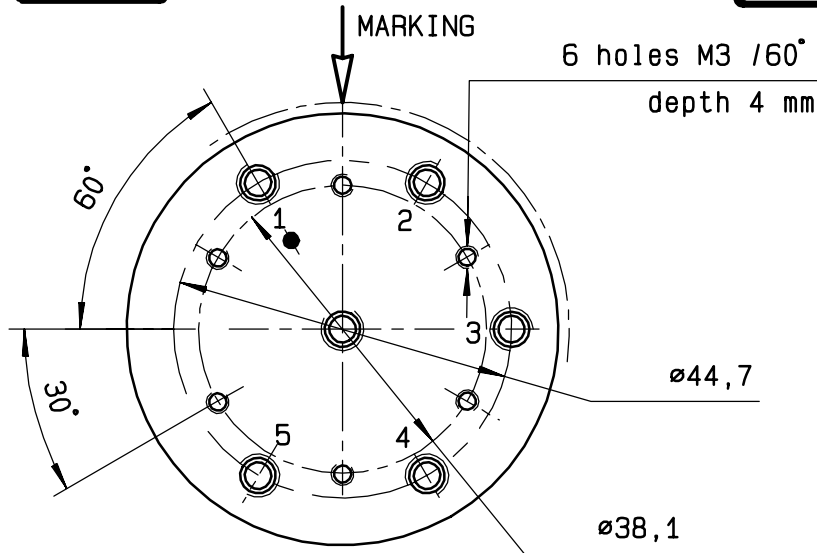

Voltage	RF continuity	Ind.
-C +1	IN ↔ 1	D.E
-C +2	IN ↔ 2	D.F
-C +3	IN ↔ 3	D.G
-C +4	IN ↔ 4	D.H
-C +5	IN ↔ 5	D.I

4-40 UNC 25 pins D-SUB male connector

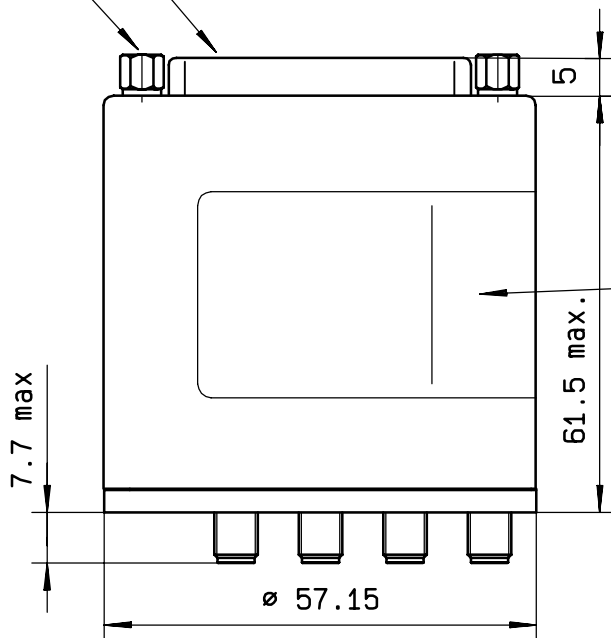

MARKING

TOP VIEW (TERMINALS)

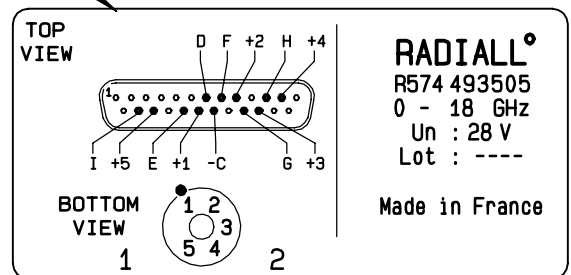

SCHEMATIC DIAGRAM

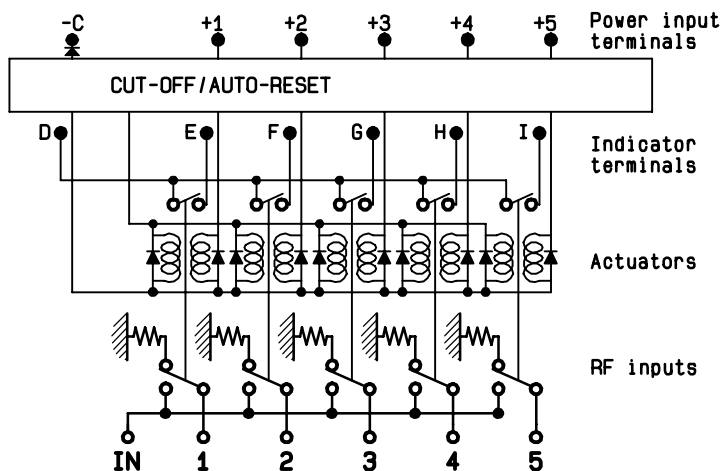

This information is given as an indication. In the continual goal to improve our products, we reserve the right to make any modifications judged necessary

4113-9212